

ALGIZ RT7

PIKAOHJE



handheld

1 TOIMITUSPAKETIN SISÄLTÖ

Alla olevat kuvat voivat poiketa todellisista tuotteista. Hankkiaksesi lisätarvikkeita tai lisäoptioita, ota yhteyttä asiakaspalveluumme.

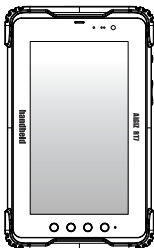

Algiz RT7 laite

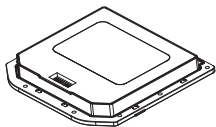

Akkupaketti



x 9 kpl

Akkupaketin ruuvit

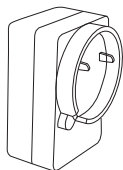

Verkkovirtalaturi



3.5mm
latauskaapeli



Micro USB
kaapeli



Headset

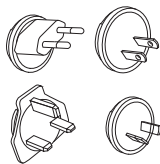

Laturi adapterit

2 ALGIZ RT7 LAITTEESI



Telakkaliitântä



Virtanäppäin

Äänen säätö

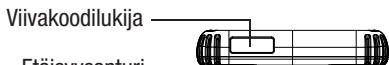

Viivakoodilukija

Etäisyysanturi

Valotunnistin

Kaiutin

Latausvalo

Etukamera

Kosketusnäyttö

Etumikrofoni

Toimintonäppäimet 4 kpl

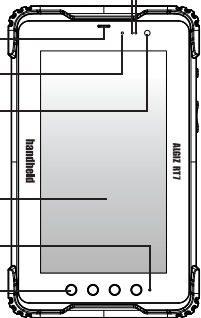

Porttisuojus

Salama

Takakamera

Kensington lukko

Kaiutin

Takamikrofoni

Akku

Kiinnityspisteet 4 kpl

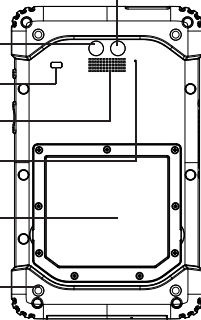

3 SIM/MICRO SD KORTIN ASENTAMINEN

Alla kuvat mihin SIM / micro SD kortti asennetaan.

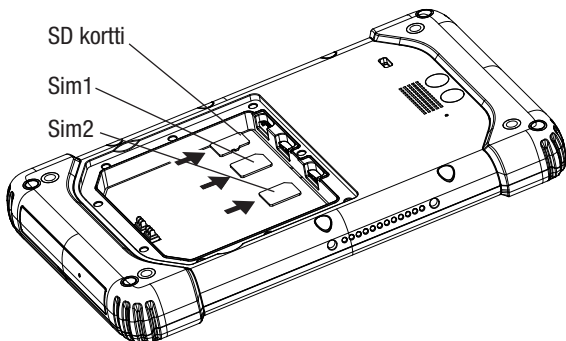

4 AKUN ASENNUS / IRROITUS

Akun asennus

1. Asenna akku kuvan osoittamalla tavalla.

2. Kiristä akku kiinnitysruuveilla (M2 X 5mm).

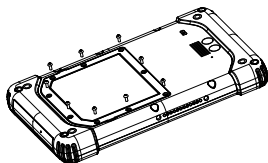
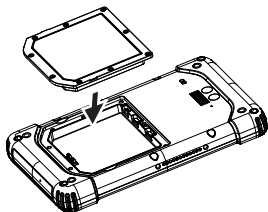

Akun irroitus

1. Sammuta laite.

2. Irroita akun kiinnitysruuvit.

3. Irroita akku.

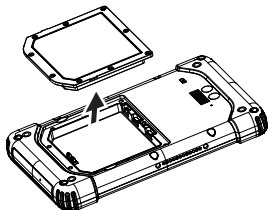
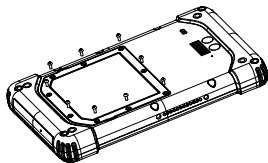

5 LAITTEEN KÄYNNISTYS/SAMMUTUS

Paina oikeassa reunassa olevaa [Virtanäppäin] käynnistääksesi ja sammuttaaksesi laitteen.

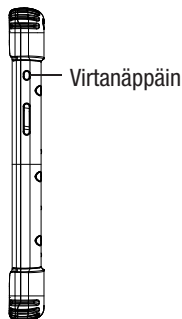

6 AKUN LATAAMINEN

Käytä Algiz RT7:n lataamiseen mukana tulevaa verkkovirtalaitetta. Lataa laitetta väh. 3 tunnin ajan ennen ensimmäistä käyttökertaa.

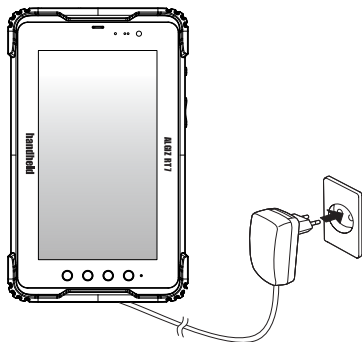

7 I/O LIITÄPORTIT

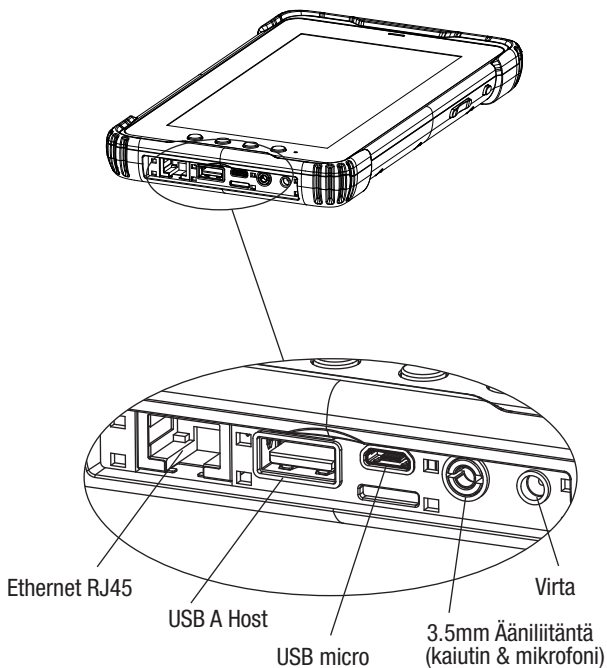

Katso lisätietoja sivulta www.handheldgroup.com/knowledgebase

Algiz RT7 is in compliance with the essential requirements and other relevant provisions of Directive 1999/5/EC. The declaration of conformity may be consulted at www.handheldgroup.com/algiz-rt7/#tab=manuals

Version 1.1

handheld
www.handheldgroup.com