

ALGIZ 7

Quick Start Guide



handheld

What's in the Box



1



2



3



4

Ref.	Item	Description
1	Battery Pack	Two Li-Polymer Battery Packs
2	12V Adapter	12V Adapter w/ standard power cord. Standard type, 1.8M
3	Screen protector film	
4	Quick start guide	Algiz 7 Quick start guide

Starting ALGIZ 7

Note: you will be asked to enter your Microsoft Windows license number that is located under the left battery.

Press and hold power button for 4 seconds to power on the unit. Follow the on-screen instructions to get started with Windows. The screen calibration may not be accurate the first time you start the computer. Follow the procedure to calibrate the touchscreen.

Insert Battery Packs

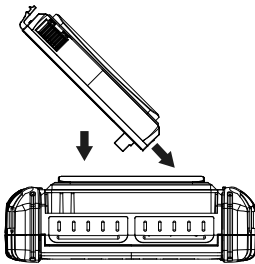

Caution

Please fully charge the batteries in advance of operating Algiz 7 for the first time. New battery packs should be fully charged before Algiz 7 is disconnected from the external power source. It takes approximately 3 hours to fully charge batteries from empty.

Screen Calibration

1. Open Control Panel > Hardware and Sound > Tablet PC Settings
2. Click Calibrate and follow instructions

Repeat step 1 and 2 until you are satisfied with the calibration





Function Keys



Ref.	Components	Description
1	Power Button*	Hold down for 4 seconds to turn the computer on
2	Menu	Menu button to control: brightness, volume, battery, power to modules, and system information
3	Up/Down/Left/ Right/OK Button	Control of up, down, left, right and Enter functions
4	F1 – F3	3 programmable buttons. Press F1 to configure

* If computer does not respond you can power off by holding down the Power Button until the LEDs switches off. Hold down for about 10 seconds.

LED Indicators

Ref.	Symbol	Indicator Status Description
Power mode		Green: System is on No light: System is off or LED indicators are off in HotTab
Storage Status		Flashing green light: SSD is reading/writing data
Radio Status		Green: Indicates that any transmitting radio is turned on (WiFi, BT, WWAN)
Battery Status		No light: 100% fully charged or power on with AC adapter Orange light: Charging Green light: Running on battery >40% Orange light: <40% and >10%, Red light: Low battery <10%

Rear Side

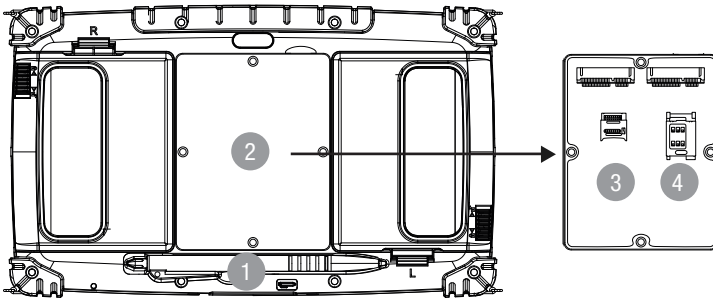

Ref.	Item	Description
1	Stylus Pen	-
2	Service Window	Expansion slots
3	SD Card	Micro SD
4	SIM Card	-

Left and Right Side

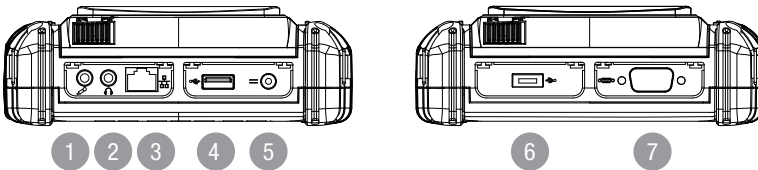

Ref.	Item	Description
1	Audio In	Microphone
2	Audio Out	Headphone
3	Ethernet (RJ45)	10/100/1000-based network
4	USB 2.0 Port	-
5	DC Power Jack	-
6	USB 2.0 Port	-
7	RS232	Accepts external connections using the interface of RS232 (D-sub 9 pins)

Please go to www.handheldgroup.com/knowledgebase to download more information.